

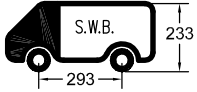









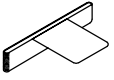

Ford Transit >2000  250x173 cm. L1 H2

| | | | | | |
|--|-----|---|-----|---|-----|
|  | 10x |  | 20x |  | 10x |
|  | 10x |  | 30x |  | 8x |
|  | 10x |  | 28x |  | 2x |
|  | 4x |  | 18x | | |
|  | 8x |  | 10x | | |

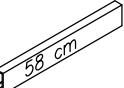

ALUFOTR250173H 12/2007

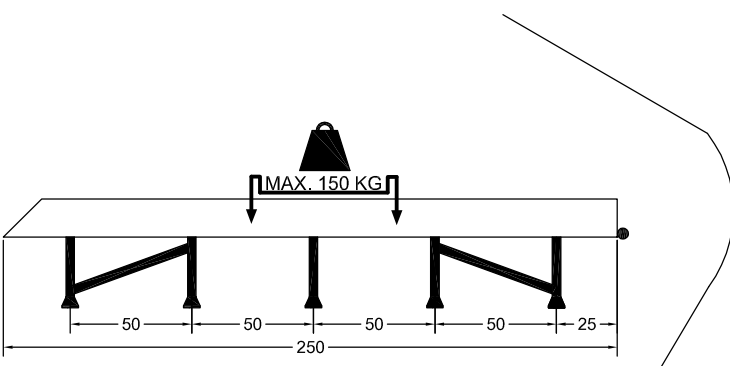