

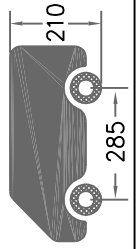













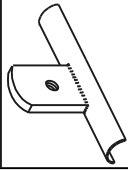





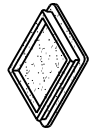

# Citroën Jumper

# Fiat Ducato

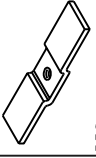
# Peugeot Boxer

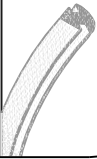
300x160 cm. L1 H1



			
6X	6X	6X	6X
			
6X	12X	6X	6X
			
6X	12X	6X	6X
			
6X	6X	6X	6X
			
12X	12X	2X	2X
			
1X			

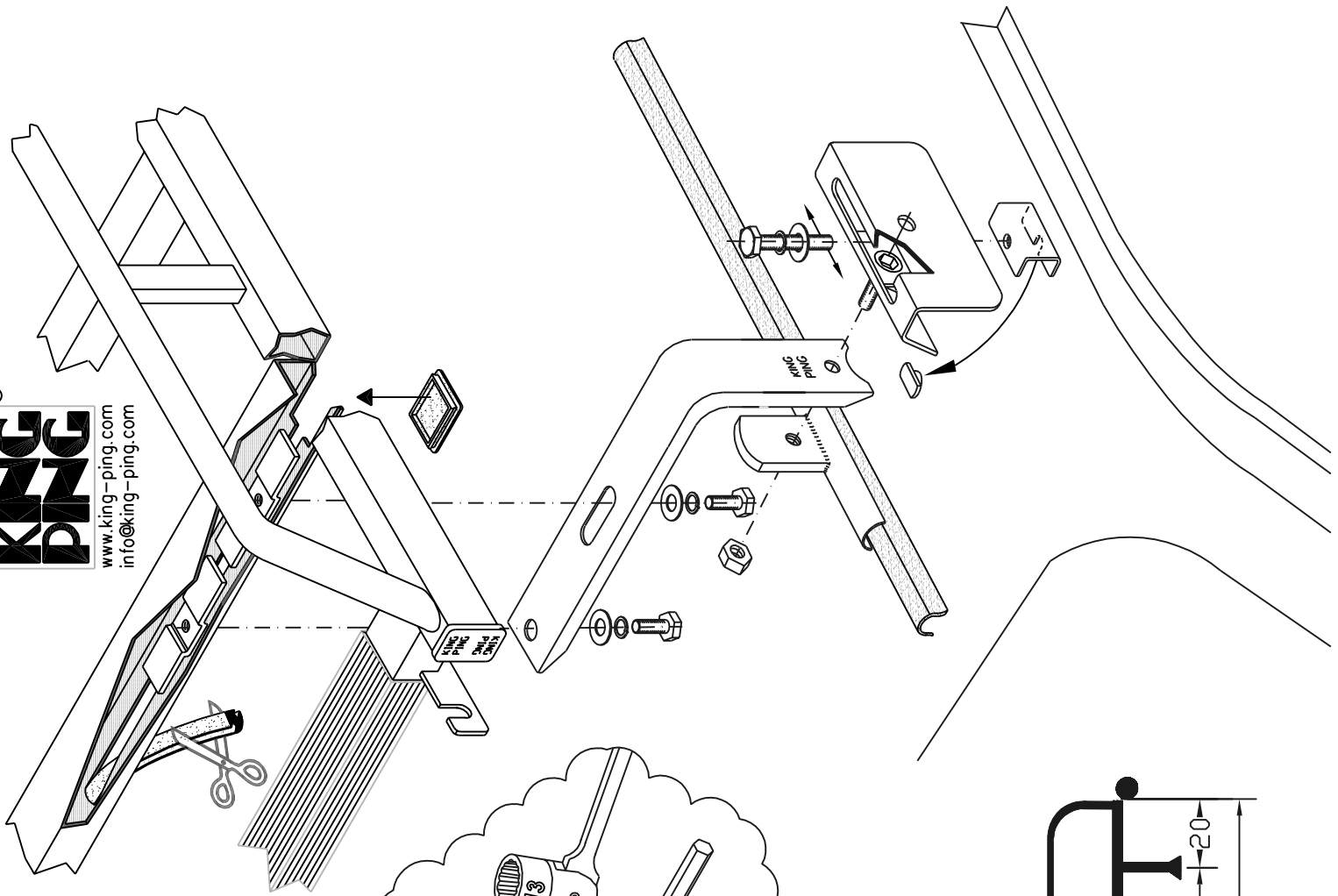
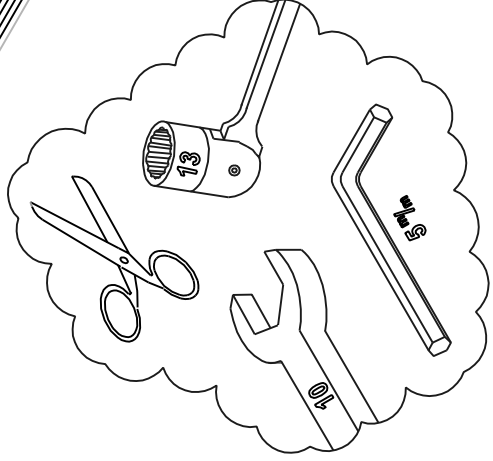

**KING PING**  
 www.king-ping.com  
 info@king-ping.com

