

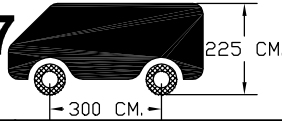

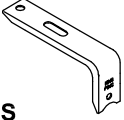







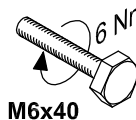
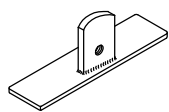

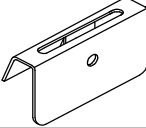
Citroën Jumper 2007 Fiat Ducato 2007 Peugeot Boxer 2007

300x160 cm. L1 H1

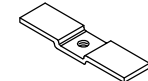

 S	6x	 14 Nm M8x20	6x	 6 Nm M6x40	6x
	6x	 M8	12x	 M6	6x
	6x	 3xD M8	12x	 3xD M6	6x
	6x	 M8	6x		6x
 14 Nm M8x20	12x	 M8	12x	 KING PING	2x
	6x		1x		

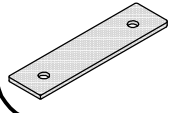
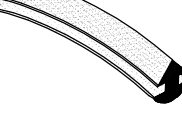
- Bij onduidelijkheden raadpleeg uw leverancier!
- Might this not be clear, please contact your supplier!
- Bei eventuellen Unklarheiten, bitten wir Sie mit Ihren Lieferanten Kontakt aufzunehmen!
- Pour plus de renseignements consultez votre fournisseur!

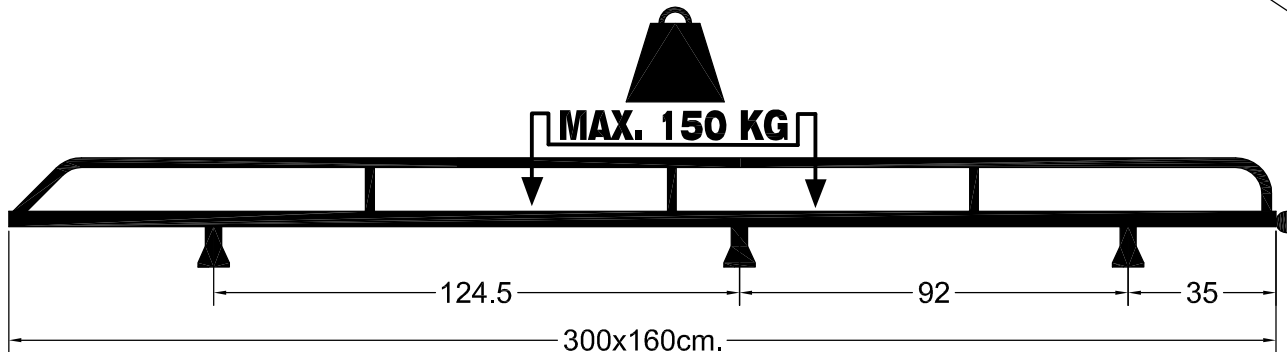

KING PING
www.king-ping.com
info@king-ping.com

