

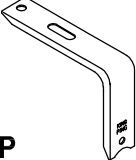

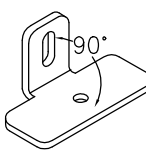





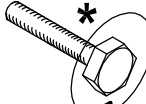

# Nissan Kubistar Renaut Kangoo

220x120 cm. Grand Volume

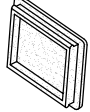
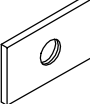
## KING PING

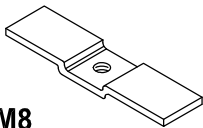
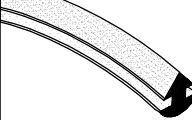
www.king-ping.com  
info@king-ping.com

	<b>4x</b>		<b>4x</b>
<b>P</b>			
	<b>12x</b>		<b>4x</b>
<b>M8x20</b>		<b>M8x25</b>	<b>Max. 20Nm.</b>
	<b>16x</b>		<b>4x</b>
<b>M8</b>			
	<b>12x</b>		<b>4x</b>
<b>3xD M8</b>			
	<b>4x</b>		<b>8x</b>
<b>M8</b>		<b>M8</b>	
	<b>8x</b>		<b>1x</b>
<b>M8</b>			
	<b>2x</b>		

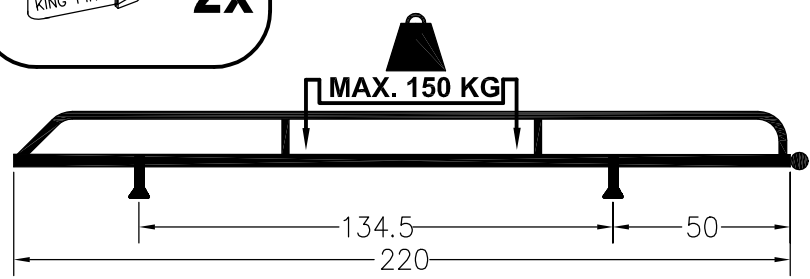
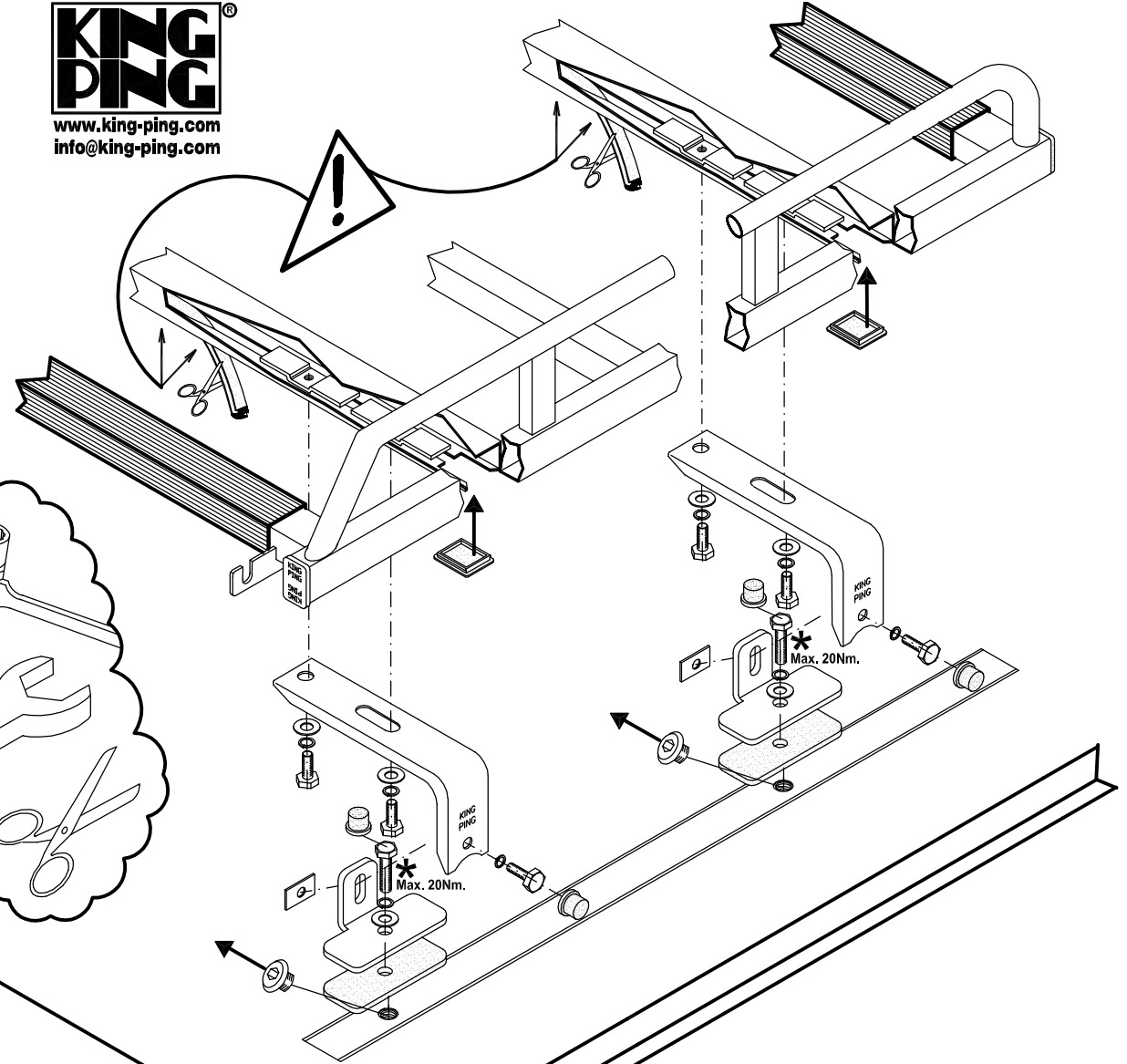
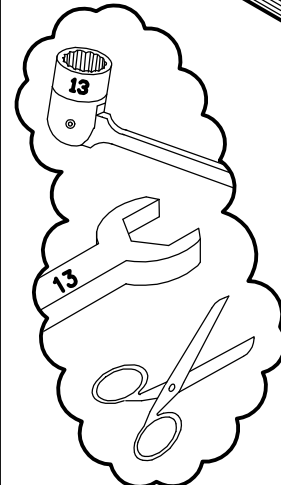

- Bij onduidelijkheden raadpleeg uw leverancier!
- Pour plus de renseignements consultez votre fournisseur!
- Bei eventuellen Unklarheiten, bitten wir Sie mit Ihren Lieferanten Kontakt aufzunehmen!
- Might this not be clear, please contact your supplier!