

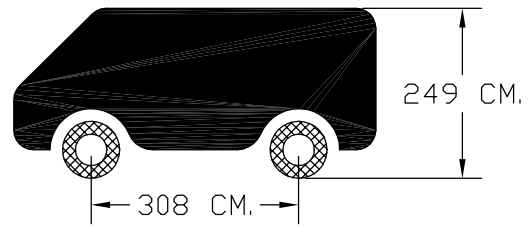

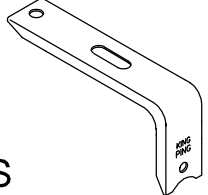

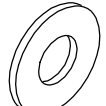

Nissan Interstar Opel Movano Renault Master

250x160 CM. (L1-H2)

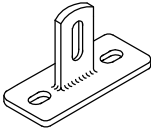

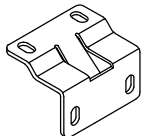
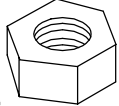
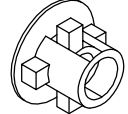
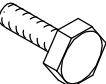
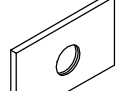
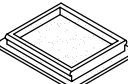
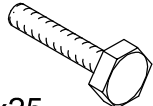
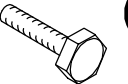
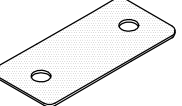
 S	6x	 3xD M8	12x	 M6	12x
	6x	 M8	30x	 3xD M6	12x
	6x	 M8	12x	 M6	12x
 A M8x20	18x	 M8	6x	 6x	6x
 B M8x25	12x	 C M6x20	12x	 12x	12x
 D 2xD M8	24x	 M8	12x	 KING PING 2x	2x
	1x				

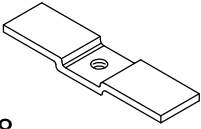
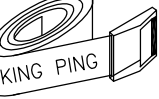
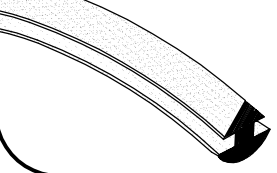
- Bij onduidelijkheden raadpleeg uw leverancier!
- Might this not be clear, please contact your supplier!
- Bei eventuellen Unklarheiten, bitten wir Sie mit Ihren Lieferanten Kontakt aufzunehmen!
- Pour plus de renseignements consultez votre fournisseur!

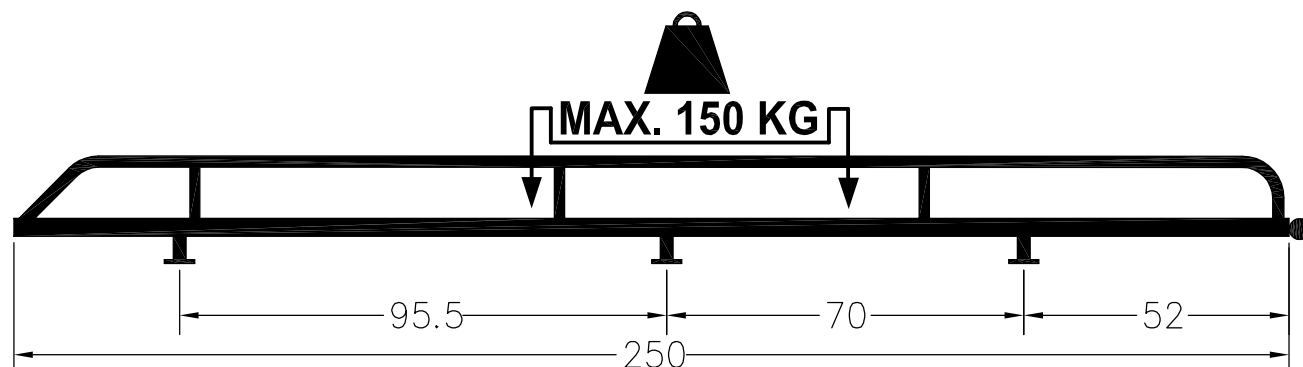

NIIN250160S OPMO250160S REMA250160S 03/2007

