

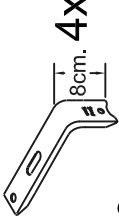

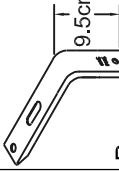

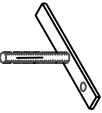





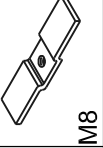





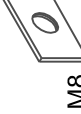

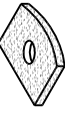

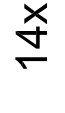

®

KING PING

www.king-ping.com
info@king-ping.com

			
VW Caddy Maxi 2008 250x120 cm.			
 S 18cm. 4X	 P 9.5cm. 4X	 2X	 2X
 S 98° 6X	 P 16X	 2X	 2X
 A M8x16 2X	 B M8x20 22X	 C M8x25 6X	 D 6X
 M8 6X	 M8 2X	 M8 6X	 M8 6X
 M10 4X	 M10 4X	 M8 14X	 M8 14X
 3xD M8 22X	 2xD M8 2X	 M8 22X	 M8 22X
 KING PING 2X	 S 1X	 8X	 8X

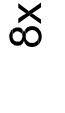
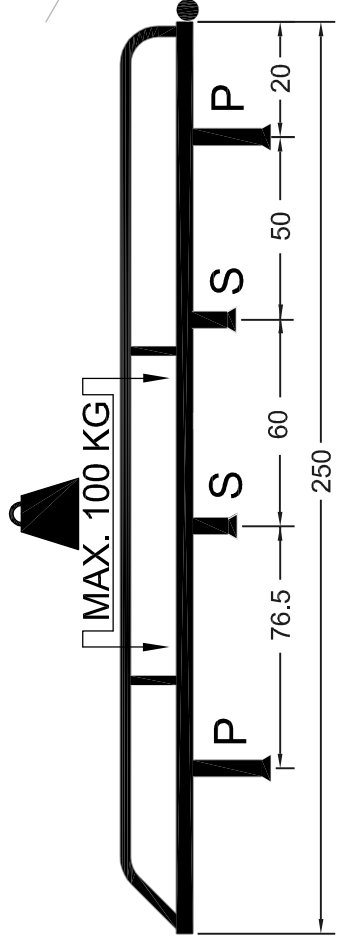
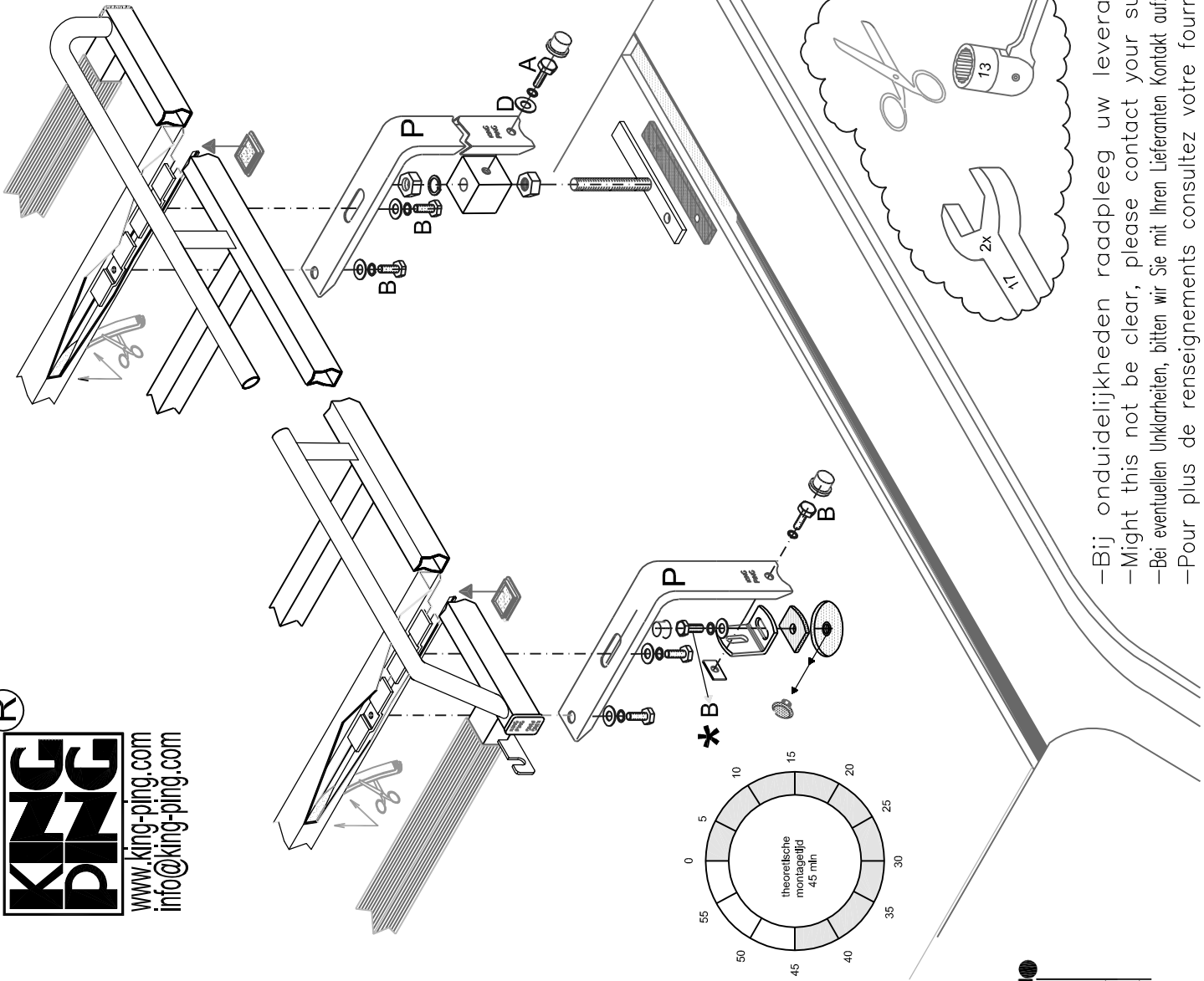

- Bij onduidelijkheden raadpleeg uw leverancier!
- Might this not be clear, please contact your supplier!
- Bei eventuellen Unklarheiten, bitten wir Sie mit Ihren Lieferanten Kontakt aufzunehmen!
- Pour plus de renseignements consultez votre fournisseur!